



SET MEDIKAL
Product Catalog 2026

We care. Since 1977

50 years of medical device manufacturing experience.

1977

Turkey's first and leading syringe manufacturing facility.

2008

Following a successful MBO and restructuring process, Set Medikal has become a key player in the medical device sector.

2020

FDA approval increased our market value and enabled our expansion into new markets.

2024

After opening its first international office in the EU, in the Netherlands, the company also established an office in San Diego, United States.



1999

The acquisition of Tyco Healthcare marked the beginning of a comprehensive modernization process.

2014

Set Medikal became Türkiye's first R&D center in its field.

2022

Addition of new production lines: IV cannulas, suction catheters, blood gas syringes, IV sets, and ENFit syringes

Now

With the launch of new products and ongoing machinery investments, Set Medikal continues its innovation and growth journey with determination.

Table of Content

set[®] syringes & needles

Syringes & needles.....	06
Syringes Terminology.....	08
2-Part Syringes.....	10
2-Part Luer Slip.....	11
2-Part Luer Lock.....	12
3-Part Syringes.....	14
3-Part Luer Slip.....	15
3-Part Luer Lock.....	16
Specialty Applications.....	18
Set Flush.....	19
Set Perfusion.....	20
Tuberculin Syringe.....	21
Gel Syringe.....	21
Blood Gas.....	22
Catheter Syringe.....	23
Veterinary.....	25
Dental.....	27
Pharmacy Trays.....	28
Needles.....	31
Standard Needle.....	32
Safety Needle.....	32

set[®] feeding

Set Feeding.....	34
Feeding Stringe Terminology.....	36
Set Oral Tip Syringe.....	38
Set ENFit [®] Syringe.....	39



set[®] diabetes

- Set Diabetes.....40
- Diabetes Terminology.....42
 - Insulin Syringe.....44
 - Pen Needle.....46

set[®] infusion

- Set infusion.....48
- Infusion Terminology.....50
- Vascular Access.....52
 - IV Catheters.....53
- Fluid Delivery Systems.....54
 - IV Set.....55
 - Flow Regulators.....55
 - Extension Line.....56
 - 3 Way Stopcocks.....56

set[®] catheters

- Set Catheters.....58
- Catheters Terminology.....60
 - Aspiration.....62
 - Tieman.....63
 - Rectal.....64
- Packaging & Sterility Options.....66**



set[®] syringes & needles

Syringes and needles have shaped Set Medikal's identity since 1977.

Over the years, we have refined every step of molding, assembly, and quality control to build a portfolio that serves millions of procedures each day.

This category brings together our broadest and most established product family, covering standard devices as well as solutions tailored for specialty use.



We care.

Syringes Instruction

What Is a Syringe?

Where and Why It Is Used ●

A syringe is used to ensure the accurate, safe, and controlled administration of liquid medications and medical solutions. Its ability to provide precise dosing, hygienic use, and ease of handling makes it an essential tool across various medical and technical fields.

It is widely used in hospitals and clinics for injections, medication delivery, and fluid aspiration; in laboratories for sample collection and liquid transfer; in veterinary practices for animal treatments; and in home care and personal healthcare applications to ensure safe and controlled use. Syringes help minimize application errors by enabling accurate dose control and smooth fluid delivery.



● How It Works

A syringe operates based on the forward and backward movement of the plunger. When the plunger is pulled back, a vacuum is created inside the barrel, allowing the liquid to be drawn in. When the plunger is pushed forward, the liquid is delivered in a controlled manner through the syringe tip. This mechanism enables accurate measurement and precise administration of fluids.

Syringe Anatomy

3-Part Syringes

Barrel

The syringe barrel is the section that holds the fluid used for various purposes. Its transparent design allows for clear visibility of the fluid level and any air bubbles present.

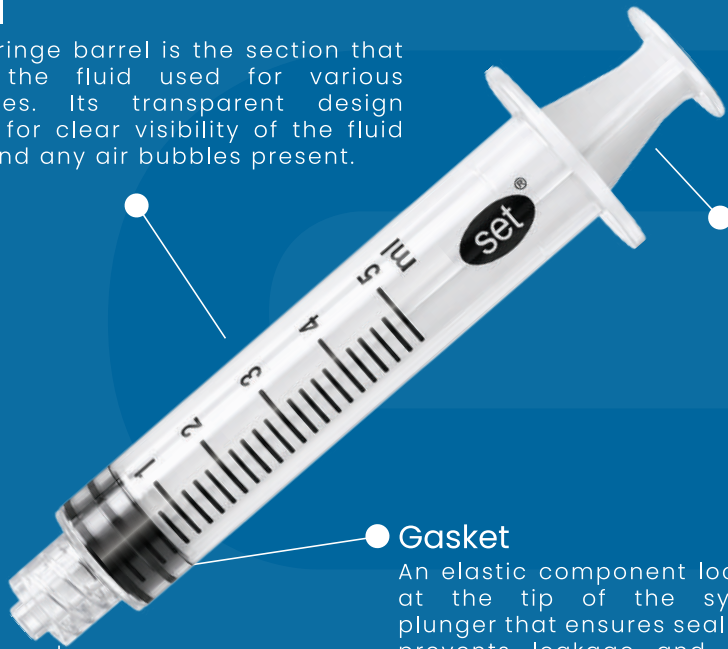

Plunger

This syringe component is used to draw in and dispense the fluid.

Gasket

An elastic component located at the tip of the syringe plunger that ensures sealing. It prevents leakage and helps provide smooth and controlled fluid movement.

Connector Tip



Luer Slip

Luer Lock

Catheter

Stop-Point

Volume Markings

Push-Button

The push-button is designed with ridges that improve grip, helping to prevent the user's thumb from slipping while pressing the plunger during injection.

2-Part Syringes

set[®] syringes & needles

2 Part Syringes

Luer Slip



We care.



Set® Inject 2-Part Luer Slip



Features

- Two-part construction (barrel + plunger)
- Silicone-free lubricant for clean and consistent plunger movement
- Clear and easy-to-read graduation marks for accurate dosing
- Transparent or UV-resistant barrel options
- Designed for general-purpose injection and aspiration
- Luer Slip tip for quick push-fit connection
- Not manufactured with silicone oil, PVC, latex, DEHP and BPA

Packaging

- Sterile single blister pack, with or without needle options
- Optional sterile tray packaging
- Non-sterile bulk or mini-bulk options
- EO-sterilized

Customization

- Plunger color customization 
- Transparent or UV-resistant barrel 
- Customizable scale options

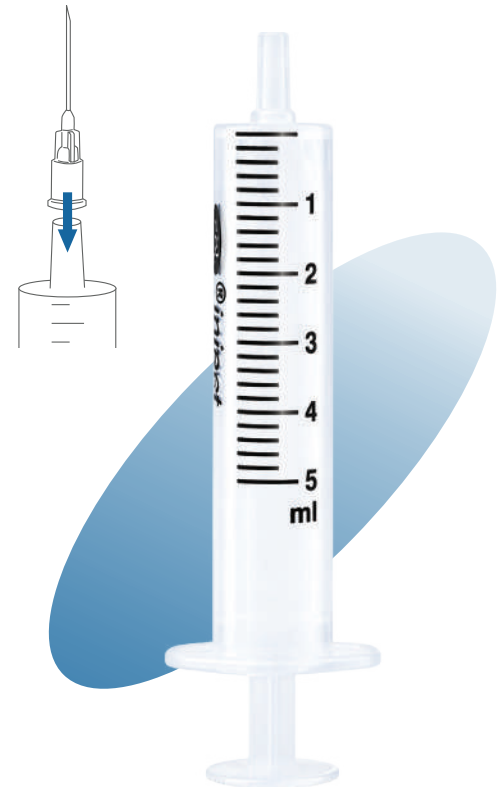

Conformance & Compliance

- Manufactured according to ISO 7886-1 and ISO 80369-7.
- Certified by EU 2017/745 (MDR)
- FDA 510(k) Cleared
- EO sterilized
- Shelf life: 5 years

Available Sizes and Types

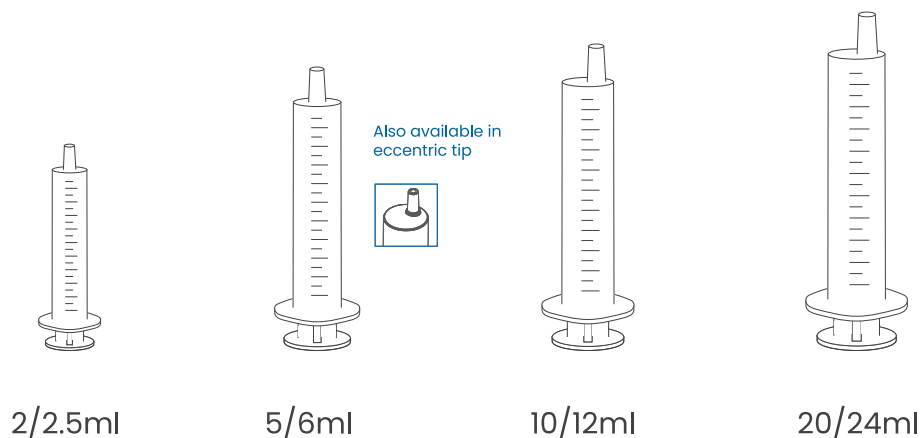

Product Table

Volume	Concentric Tip	Eccentric Tip	Graduation	Graduated Capacity	Units Box	Units Carton
2/2.5 ml	•		0.1 ml	2.5 ml	100/350 pcs	2400/2800 pcs
5/6 ml	•	•	0.2 ml	6.0 ml	100/250 pcs	1600/2000 pcs
10/12 ml		•	0.5 ml	12.0 ml	100/150 pcs	1200/1200 pcs
20/24 ml		•	1.0 ml	24.0 ml	100 pcs	600 pcs

*Reference numbers are subject to change based on packaging, labeling, regulatory, or regional distribution updates.

set[®] syringes & needles

2 Part Syringes

Luer Lock



We care.



Set® Inject 2-Part Luer Lock

Features

- Two-part construction (barrel + plunger)
- Silicone-free lubricant for clean and consistent plunger movement
- Clear and easy-to-read graduation marks for accurate dosing
- Transparent or UV-resistant barrel options
- Designed for general-purpose injection and aspiration
- Luer Lock threaded connection for secure and stable attachment
- Not manufactured with silicone oil, PVC, latex, DEHP and BPA

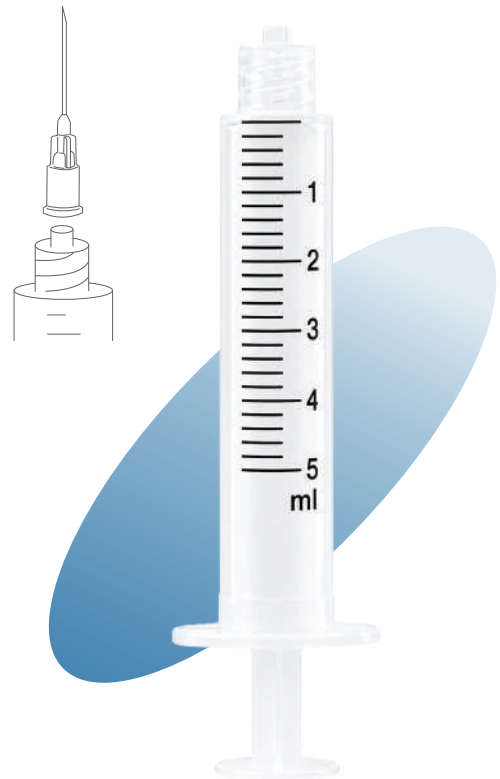

Packaging

- Sterile single blister pack, with or without needle options
- Optional sterile tray packaging
- Non-sterile bulk or mini-bulk options
- EO-sterilized

Customization

- Plunger color customization 
- Transparent or UV-resistant barrel 
- Customizable scale options

Conformance & Compliance

- Manufactured according to ISO 7886-1 and ISO 80369-7.
- EO sterilized
- Shelf life: 5 years

Available Sizes and Types

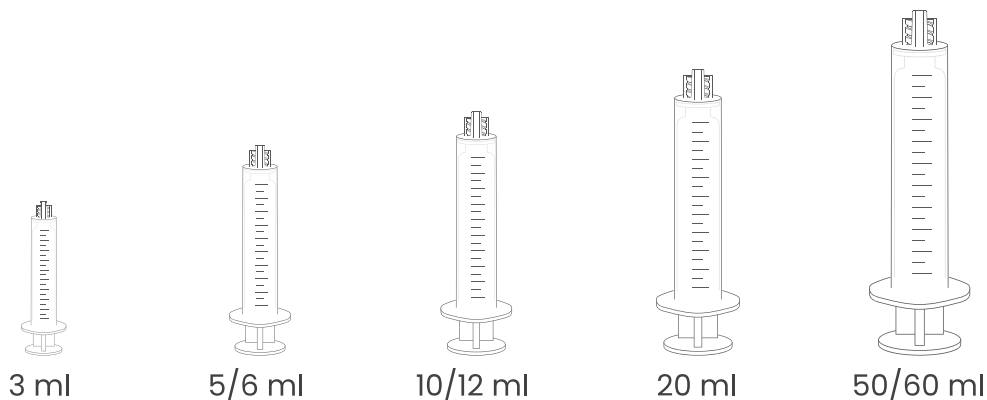

Product Table

Volume	Graduation	Graduated Capacity	Units / Box	Units / Carton
3 ml	0.1 ml	3.0 ml	100/350 pcs	2400/2800 pcs
5/6 ml	0.2 ml	6.0 ml	100/250 pcs	1600/2000 pcs
10/12 ml	0.5 ml	12.0 ml	100/150 pcs	1200/1200 pcs
20/24 ml	1.0 ml	20.0 ml	100 pcs	600 pcs
50/60 ml	1.0 ml	60.0 ml	60 pcs	240 pcs

* Reference numbers are subject to change based on packaging, labeling, regulatory, or regional distribution updates.

set[®] syringes & needles

3 Part Syringes

Luer Slip



We care.



Set® Inject 3-Part Luer Slip

Features

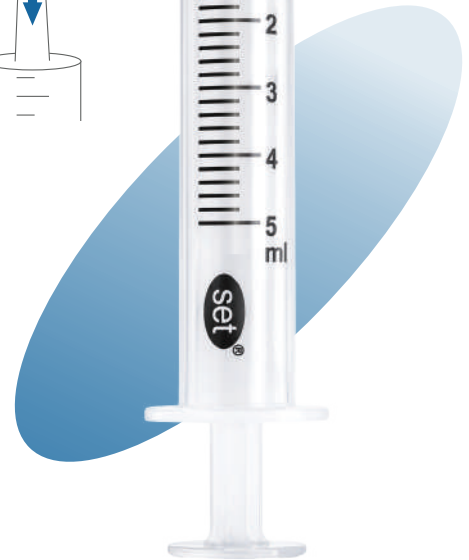
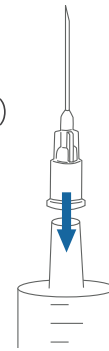

- Three-part construction (barrel + plunger + latex-free isoprene gasket)
- Silicone-sprayed barrel for smooth and controlled movement
- High sealing performance due to precision-fitted gasket
- Clear, precise graduation marks for accurate dosing
- Transparent or UV-resistant barrel options
- Wide capacity range available: 1 ml – 50 ml
- Luer Slip tip for quick push-fit connection
- Not manufactured with PVC, latex, DEHP and BPA



Packaging

- Sterile single blister pack, with or without needle options
- Optional sterile tray packaging
- Non-sterile bulk or mini-bulk options
- EO-sterilized

Customization

- Plunger color customization 
- Transparent or UV-resistant barrel 
- Customizable scale options 

Conformance & Compliance

- Manufactured according to ISO 7886-1 and ISO 80369-7.
- Certified by EU 2017/745 (MDR)
- FDA 510(k) Cleared
- EO sterilized
- Shelf life: 5 years

Available Sizes and Types

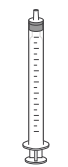

1 ml

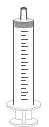

2/2,5 ml



3 ml

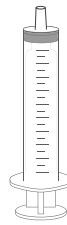

5 ml



Eccentric Option

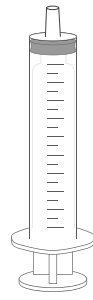

10/12 ml



Eccentric Option

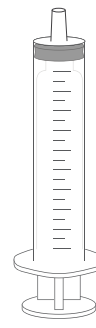

20 ml

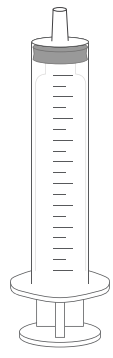

50 ml

Product Table

Volume	Concentric Tip	Eccentric Tip	Graduation	Graduated Capacity	Units Box	Units Carton
1 ml	•		0.1 ml	1 ml	100/500 pcs	3200/3000 pcs
2/2,5 ml	•		0.1 ml	2.5 ml	100/350 pcs	2400/2800 pcs
3 ml	•		0.1 ml	3.0 ml	100/350 pcs	2400/2800 pcs
5 ml	•	•	0.2 ml	5.0 ml	100/250 pcs	1600/2000 pcs
10/12 ml	•	•	0.5 ml	12.0 ml	100/150 pcs	1200/1200 pcs
20 ml		•	1.0 ml	20.0 ml	100 pcs	600 pcs
50 ml		•	1.0 ml	60.0 ml	60 pcs	240 pcs

*Reference numbers are subject to change based on packaging, labeling, regulatory, or regional distribution updates.

set[®] syringes & needles

3 Part Syringes

Luer Lock



We care.



Set® Inject 3 Part Luer Lock

Features



- Three-part construction (barrel + plunger + latex-free isoprene gasket)
- Silicone-sprayed barrel for smooth and controlled movement
- High sealing performance due to precision-fitted gasket
- Clear, precise graduation marks for accurate dosing
- Transparent or UV-resistant barrel options
- Wide capacity range available: 1 ml – 50 ml
- Luer Lock threaded connection for secure and stable attachment
- Not manufactured with PVC, latex, DEHP and BPA



Packaging

- Sterile single blister pack, with or without needle options
- Optional sterile tray packaging
- Non-sterile bulk or mini-bulk options
- EO-sterilized

Customization

- Plunger color customization 
- Transparent or UV-resistant barrel 
- Customizable scale options

Conformance & Compliance

- Manufactured according to ISO 7886-1 and ISO 80369-7.
- Certified by EU 2017/745 (MDR)
- FDA 510(k) Cleared
- EO sterilized
- Shelf life: 5 years

Available Sizes and Types

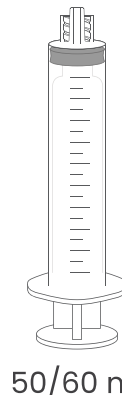
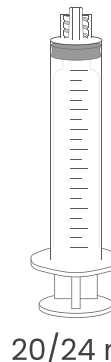
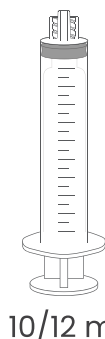
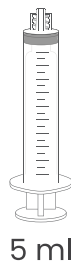
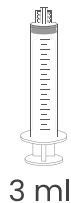
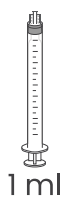
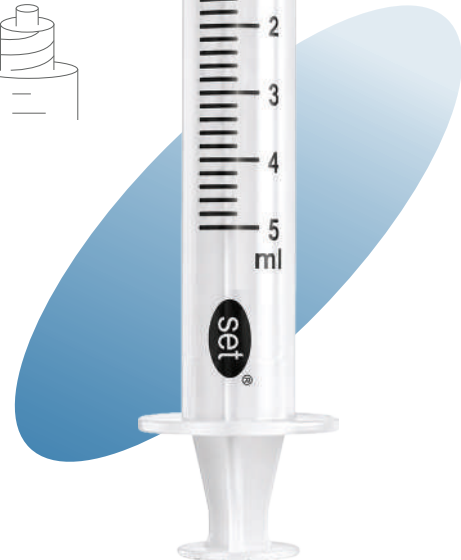

1 ml

3 ml

5 ml

10/12 ml

20/24 ml

50/60 ml

Product Table

Volume	Graduation	Graduated Capacity	Units / Box	Units / Carton
1 ml	0.1 ml	1 ml	100/500 pcs	3200/3000 pcs
3 ml	0.1 ml	3.0 ml	100/350 pcs	2400/2800 pcs
5 ml	0.2 ml	5.0 ml	100/250 pcs	1600/2000 pcs
10/12 ml	0.5 ml	12.0 ml	100/150 pcs	1200/1200 pcs
20 ml	1.0 ml	20.0 ml	100 pcs	600 pcs
50/60 ml	1.0 ml	60.0 ml	60 pcs	240 pcs

*Reference numbers are subject to change based on packaging, labeling, regulatory, or regional distribution updates.

set[®] syringes & needles

Specialty Applications



We care.

Set® Flush

Set® Flush is a ready-to-use 0.9% sodium chloride prefilled syringe designed for routine flushing of compatible intravenous tubing and indwelling vascular access devices.

Features

- Ready-to-use 10 mL flush syringe prefilled with 0.9% sodium chloride solution for flushing IV lines and vascular access devices.
- Single-use, sterile fluid path to support good infection prevention practice and reduce the risk of contamination associated with manual preparation
- 10 mL barrel diameter helps keep flushing pressure low and is aligned with common recommendations for flushing vascular access devices
- Clear, easy-to-read scale to support controlled flushing and visual confirmation of the solution
- Luer lock tip for secure connection to standard IV access devices.
- Free from added preservatives and designed for single patient use only
- Not made with natural rubber latex, DEHP, PVC or BPA
- Sterilized with gamma

Packaging

- Individually packed to support aseptic handling at the point of use
- Tamper-evident wrap and protective cap to help maintain package integrity until use

Conformance & Compliance

- Manufactured according to ISO 7886-1
- ISO 80369-7
- ISO 11040-6





Set® Perfusion



Features

- Optimized for use with power-driven syringe pumps
- Three-part design with latex-free isoprene gasket
- Excellent sealing with no air leakage at gasket or tip
- Smooth, controlled plunger movement with silicone lubricant
- Polypropylene barrel and plunger for high chemical resistance
- Clear 1 ml graduation for accurate infusion control
- Luer Lock tip with 6% taper and 1.2 mm connector
- Transparent, UV-resistant, or opaque barrel options
- Large-diameter barrel for improved fluid-level tracking

Packaging

- Sterile single blister pack

Customization

- Transparent, UV-resistant amber, or opaque barrel options 
- Extended graduation feature (50 ml total scale) 

Conformance & Compliance





- Manufactured according to ISO 7886-1 and ISO 80369-7.
- FDA 510(k) Cleared
- Certified by EU 2017/745 (MDR)
- EO sterilized
- Shelf life: 5 years

Available Types





Perfusion tip

Most Preferred Needles

-  14G x 1 1/4" 2 x 30 mm
-  15G x 1" 1.8 x 25 mm
-  16G x 1" 1.6 x 25 mm
-  18G x 1 1/2" 1.2 x 38 mm

Product Table

Volume	Barrel Color	Graduation	Graduated Capacity	Units Box	Units Carton
50ml		1.0 ml	50.0 ml	60 pcs	240 pcs
50ml		1.0 ml	50.0 ml	60 pcs	240 pcs
50ml		1.0 ml	50.0 ml	60 pcs	240 pcs

*Reference numbers are subject to change based on packaging, labeling, regulatory, regional distribution updates, or requested customization.



Set® Tuberculin

Features

- Medical-grade polypropylene barrel and plunger
- Latex-free isoprene rubber gasket ensuring excellent sealing
- Smooth and consistent plunger movement with silicone lubricant
- Low dead space (<0.1 ml) minimizing medication waste
- Clear graduation (0.01–0.02 ml) for precise low-dose injections
- Fixed needle or Luer Slip (6% taper) configuration depending on model
- Accurate and reliable delivery for tuberculin and allergy testing

Packaging

- Sterile single blister pack

Customization

- Plunger color options 
- Transparent or UV-resistant amber barrel 

Conformance & Compliance

- ISO 6009-ISO 80369-7-ISO 9626
- EU 2017/745 (MDR)
- EO sterilized
- Shelf life: 5 years



Product Table

Volume	Connector	Graduation	Graduated Capacity	Needle	Units Box	Units Carton
1 ml	Luer Slip	0.01 ml	1.0 ml		100/500 pcs	3200/3000 pcs
1 ml	Luer Slip	0.01 ml	1.0 ml	26G-29G-30G-31G	100/500 pcs	3200/3000 pcs

*Reference numbers are subject to change based on packaging, labeling, regulatory, regional distribution updates, or requested customization.

Set® Gel Syringe

Features

- Made of medical-grade polypropylene
- Latex-free bromobutyl rubber stopper ensuring excellent sealing
- Smooth and consistent plunger movement with silicone lubricant
- Clear and readable graduation (0.2 ml / 0.5 ml)
- Low dead space minimizing residue (<0.075 ml / <0.10 ml)
- Designed for applying and dispensing gel-based lubricants
- Catheter-tip design for controlled gel delivery
- Transparent barrel for easy visibility

Packaging

- Double nylon pouch
- Outer dopel carton (non-sterile packaging)

Conformance & Compliance

- EU 2017/745 (MDR)
- Shelf life: 5 years

Available Sizes

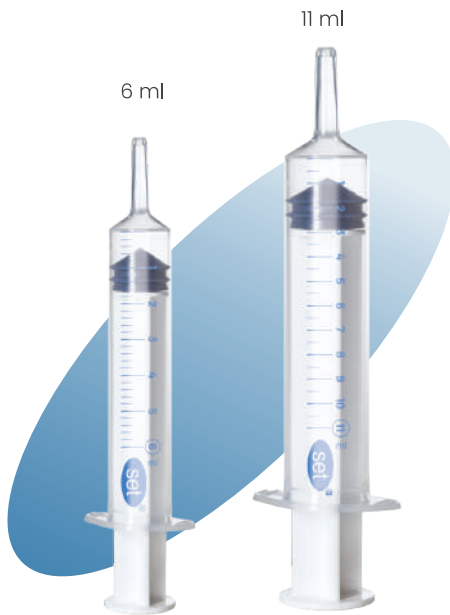
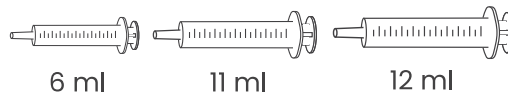

Product Table

Volume	Connector	Graduation	Graduated Capacity	Units Carton
6 ml	Luer	0.2 ml	6 ml	2200 pcs
11 ml	Luer	0.5 ml	11 ml	1400 pcs
12 ml	Luer	0.5 ml	12 ml	1400 pcs

*Reference numbers are subject to change based on packaging, labeling, regulatory, regional distribution updates, or requested customization.



Set® Blood Gas Syringe

Features

- Pre-heparinized design (helps prevent coagulation)
- Three-part design with latex-free
- Minimizes air bubble formation
- Secure sealing system
- Clear and precise graduation markings
- Ergonomic design for easy handling
- Individually blister packed
- Preloaded with approximately 80 IU dry, electrolyte-balanced lithium heparin for anticoagulation

Packaging

- Sterile single blister pack
- With or without needle options

Customization

- Color options for plunger  



Syringe with heparin paper

Conformance & Compliance

- Manufactured according to ISO 7886-1 and ISO 80369-7.
- Certified by EU 2017/745 (MDR)
- EO sterilized
- Shelf life: 2 years

Product Table

Volume	With Needle	Graduation	Graduated Capacity	Units Box	Units Carton
2 ml		0.01 ml	2.0 ml	350 pcs	2800 pcs
2 ml	22Gx1 1/4	0.01 ml	2.0 ml	350 pcs	2800 pcs
2 ml		0.01 ml	2.0 ml	100 pcs	2000 pcs
2 ml	22Gx1 1/4	0.01 ml	2.0 ml	100 pcs	2000 pcs

*Reference numbers are subject to change based on packaging, labeling, regulatory, regional distribution updates, or requested customization.

Features

- Barrel made of medical-grade polypropylene
- Plunger made of medical-grade polypropylene
- Latex-free isoprene rubber gasket ensuring excellent sealing
- Smooth and consistent plunger movement with silicone lubricant
- No air leakage from gasket or tip
- Clear and legible 1 ml graduation
- Low dead space (<0.20 ml)
- Catheter-tip connector for controlled fluid administration
- Transparent barrel for easy visibility

Packaging

- Sterile single blister pack

Customization

- Plunger color options 

Conformance & Compliance

- Manufactured according to ISO 7886-1
- Certified by EU 2017/745 (MDR)
- FDA 510(k) Cleared
- EO sterilized
- Shelf life: 5 years

Product Table

Volume	Connector	Graduation	Graduated Capacity	Units Box	Units Carton
50 ml	Catheter Tip	1 ml	60 ml	60 pcs	240 pcs
50 ml	• Catheter Tip	1 ml	60 ml	60 pcs	240 pcs

*Reference numbers are subject to change based on packaging, labeling, regulatory, regional distribution updates, or requested customization.

•Version with cap and adapter

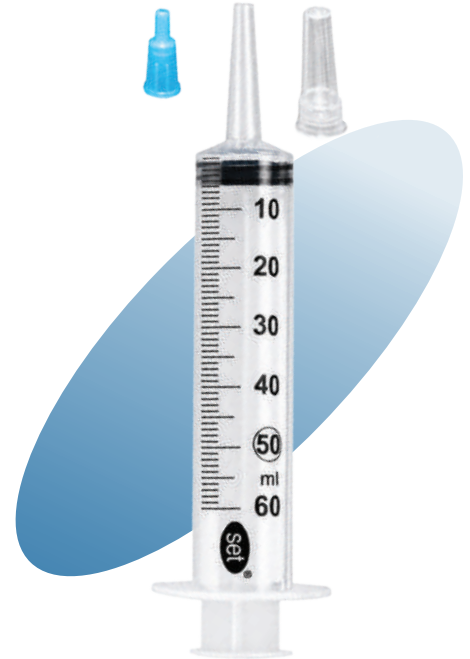

set[®] syringes & needles

Specialty **Applications**

Veterinary Syringes

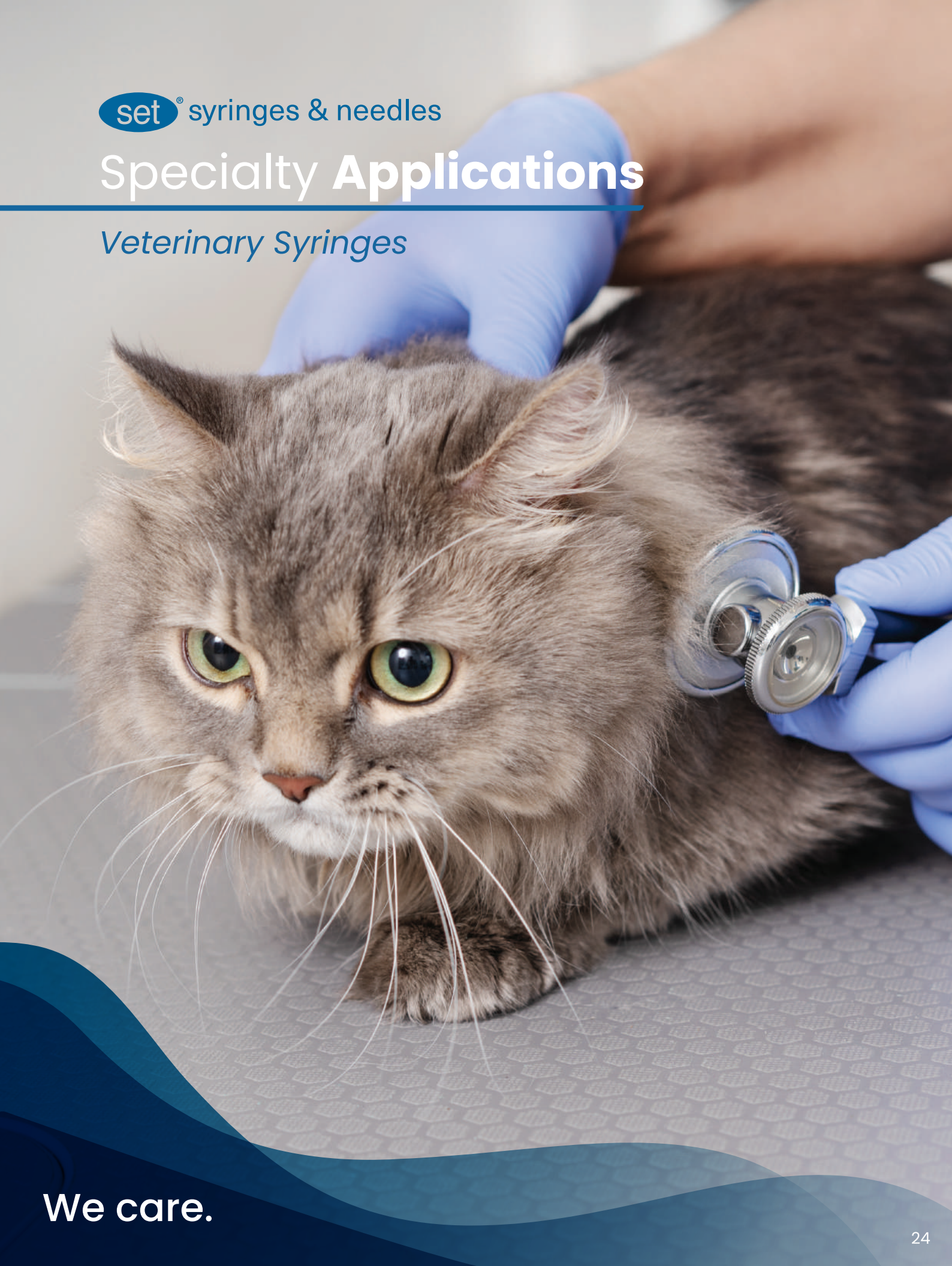

We care.



Set® Veterinary Syringes

Features

- Barrel made of medical-grade polypropylene
- Plunger made of medical-grade polyethylene/polypropylene
- Free from PVC, Latex, DEHP and BPA
- Medical-grade rubber gasket
- Luer Slip and Luer Lock connector
- Easy and comfortable plunger movement
- Black graduation for easy reading and accurate dosing
- Safe plunger backstop preventing the easy exit of the plunger from the barrel
- Sterile single packaging

Packaging

- With mounted or bi-packed needle

Customization

- Plunger color options 

Conformance & Compliance

- Manufactured according to ISO 7886-1 and ISO 80369-7



Product Table

Volume	2 Part Syringe	3 Part Syringe	Units Box	Units Carton
1 ml		•	100/500 pcs	3200/3000 pcs
2 ml	•	•	100/350 pcs	2400/2800 pcs
3 ml		•	100/350 pcs	2400/2800 pcs
5 ml	•	•	100/250 pcs	1600/2000 pcs
10 ml	•	•	100/150 pcs	1000/1200 pcs
20 ml	•	•	100 pcs	600 pcs
50 ml		•	60 pcs	240 pcs

*Reference numbers are subject to change based on packaging, labeling, regulatory, regional distribution updates, or requested customization.

set[®] syringes & needles

Specialty Applications

Dental



We care.



Set® Dental Syringe

Features

- Barrel made of medical-grade polypropylene.
- Plunger made of medical-grade polyethylene.
- Free from PVC, Latex, DEHP and BPA.
- Free from silicone oil (for 2-piece syringes).
- Medical-grade rubber gasket.
- Luer Slip and Luer Lock connector.
- Easy and comfortable plunger movement.
- Black graduation for easy reading and accurate dosing.
- Color options for plunger for precise dosage.
- Sterile single packaging with and without detached needle options.

Packaging

- Single packaging or customized tray options.
- Sterile or non-sterile.
- With or without needle options

Customization

- Color options for plunger 
- Clear / transparent or UV-resistant amber barrel 



Conformance & Compliance

- Manufactured according to ISO 7886-1 and ISO 80369-7
- Certified by EU 2017/745 (MDR)
- FDA 510(k) Cleared

Dental Needle Options



27G x 1 1/2"
0.4 x 40 mm



27G x 2"
0.4 x 50 mm

Product Table

Volume	Connector	Gauge x Length (inch)	Length	Units Box	Units Carton
2 ml	Luer Slip	27G x 1 1/2"	0.4 x 40mm	300 pcs	2400 pcs
2 ml	Luer Slip	27G x 2"	0.4 x 50mm	300 pcs	2400 pcs
2 ml	Luer Slip	27G x 1 1/2"	0.4 x 40mm	300 pcs	2400 pcs
2 ml	Luer Slip	27G x 2"	0.4 x 50mm	300 pcs	2400 pcs
2 ml	Luer Lock	27G x 1 1/2"	0.4 x 40mm	300 pcs	2400 pcs
2 ml	Luer Lock	27G x 2"	0.4 x 50mm	300 pcs	2400 pcs

*Reference numbers are subject to change based on packaging, labeling, regulatory, regional distribution updates, or requested customization.

set[®] syringes & needles

Specialty Applications

Pharmacy Tray



We care.



Set® inject Pharmacy Tray

Features

- Barrel made of medical-grade polypropylene.
- Plunger made of medical-grade polyethylene/polypropylene.
- Free from PVC, Latex, DEHP and BPA.
- Easy and comfortable plunger movement.
- Black graduation for easy reading and accurate dosing.
- Color options for plunger for precise dosage.

Customization

- Color options for plunger
- Clear / transparent or UV-resistant amber barrel

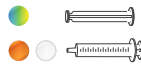

Tray Options

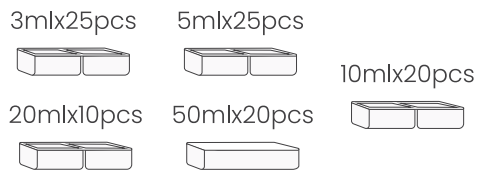

Conformance & Compliance

- Manufactured according to ISO 7886-1 and ISO 80369-7

Set® inject Pharmacy Tray

Features

- Barrel made of medical-grade polypropylene
- Plunger made of medical-grade polyethylene/polypropylene.
- Free from PVC, Latex, DEHP and BPA
- Medical-grade rubber gasket
- Luer lock connector tip
- Easy and comfortable plunger movement
- Black graduation for easy reading and accurate dosing
- Color options for plunger for precise dosage

Customization

- Color options for plunger
- Clear / transparent or UV-resistant amber barrel

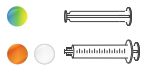

Tray Options

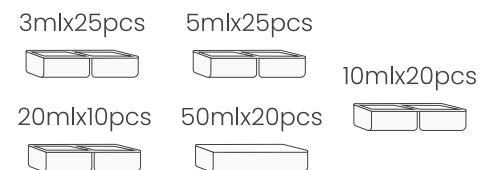

Conformance & Compliance

- Manufactured according to ISO 7886-1 and ISO 80369-7



set[®] syringes & needles

Needles



We care.



Set® Lance

Standard Hypodermic Needle

Features

- Made of stainless steel (SS304) hypodermic needle
- Atraumatic, triple-bevel needle tip for smooth penetration
- Easy and controlled insertion thanks to silicone lubrication
- No air leakage between needle, hub, or protective components
- Available in multiple gauges and lengths (14G–30G)
- Transparent needle cap and hub in standardized color codes
- Designed for injection, aspiration, and preparation of medical fluids
- Single-use, sterile product ensuring patient and user safety

Packaging Options

- Units per box/case 900-9000pcs
- Units per box/case 100-8000pcs

Conformance & Compliance

- EU 2017/745 (MDR)
- ISO 6009-ISO 7864-ISO 80369-7-ISO 9626
- FDA 510(k) Cleared
- EO sterilization
- Shelf life: 5 years

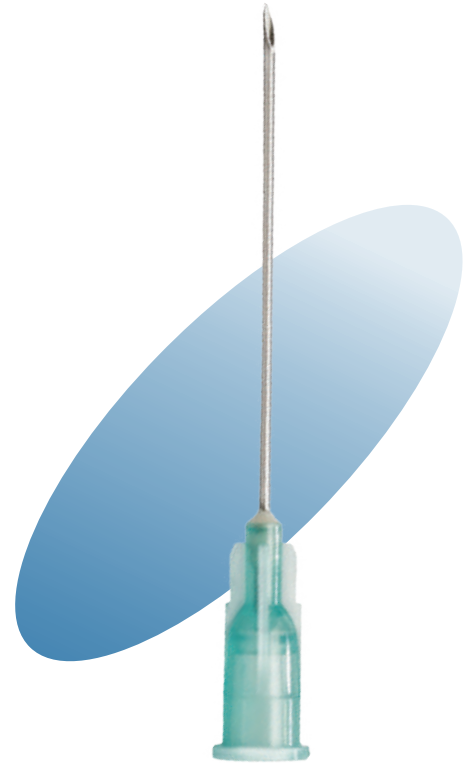

Set® Lance

Safety Hypodermic Needle

Features

- Made of stainless steel (SS304) hypodermic needle
- Atraumatic, triple-bevel needle tip for smooth penetration
- Easy and controlled insertion thanks to silicone lubrication
- No air leakage between needle, hub, or protective components
- Available in multiple gauges and lengths (14G–30G)
- Transparent needle cap, holder, and safety shield in various color options
- Single-use, sterile product designed for safe injection, aspiration, and fluid preparation
- Secure safety cap mechanism to reduce needlestick injury risk

Packaging Options

- Units per box/case 350-3500pcs
- Units per box/case 100-2500pcs

Conformance & Compliance

- EU 2017/745 (MDR)
- ISO 6009-ISO 7864-ISO 80369-7-ISO 9626
- EO sterilization
- Shelf life: 5 years





Set® Lance

Standard Hypodermic Needle – Safety Hypodermic Needle

Available Sizes

Gauge	Length (inches)	Length (mm)	Standard Needle	Safety Needle
16G	1"	25mm	•	
18G	1"	25mm	•	•
	1 1/2"	38mm	•	•
19G	1"	25mm	•	•
	1 1/2"	38mm	•	•
20G	1"	25mm	•	•
	1 1/2"	38mm	•	•
21G	5/8"	16mm	•	
	1"	25mm	•	•
	1 1/2"	38mm	•	•
22G	1"	25mm	•	•
	3/4"	19mm	•	•
	1 1/4"	32mm	•	•
	1 1/2"	38mm	•	•
23G	1"	25mm	•	•
	1 1/4"	32mm	•	•
	1 1/2"	38mm	•	
24G	1"	25mm	•	•
	1/4"	32mm	•	•
25G	1/2"	13mm	•	
	5/8"	16mm	•	•
	1"	25mm	•	•
26G	1/2"	13mm	•	
	1"	25mm	•	•
27G	1/2"	13mm	•	•
	2"	50mm	•	

*Regular wall for 24G and above, thin wall for below 24G





set[®] feeding

Enteral nutrition requires equipment that is dependable in every routine. Our feeding portfolio supports safe and consistent enteral delivery across clinical settings.

With products designed for routine use in hospitals, pharmacies, and home-care environments, this category provides a clear overview of our feeding syringes and related accessories.



We care.

Feeding Instruction

What Is a Feeding Syringe?

ENFit® Tip

The ENFit® connector is a standardized connection designed for enteral feeding systems that improves patient safety by preventing misconnections.

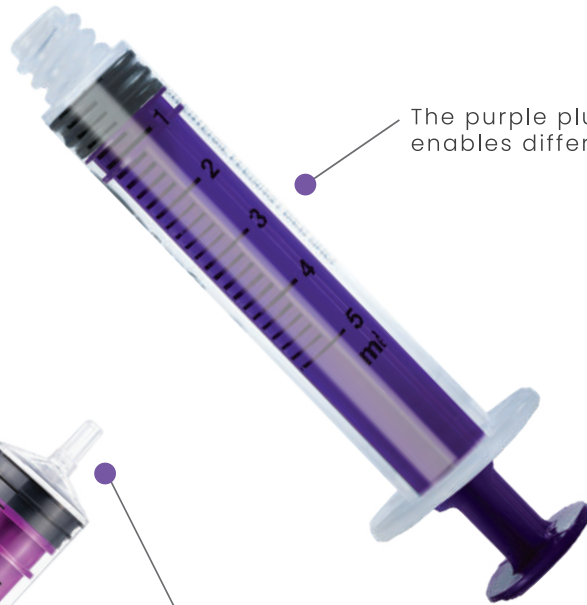

The purple plunger that enables differentiation.



Oral Tip

Oral tip syringe is designed for oral feeding use, helping prevent misconnections and ensuring safe, accurate administration.

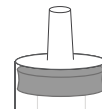



Set® Oral



Features

- Designed for safe dispensing and oral administration of liquids, featuring a self-righting cap design
- Smooth plunger movement with silicone lubrication
- Latex-free gasket ensuring reliable sealing
- Clear and accurate graduation for precise dosing
- Available in 1 ml, 3 ml, and 5 ml sizes ensuring enhanced micro-dosing accuracy
- Transparent barrel offering easy visibility of contents
- Single-use device ensuring patient and user safety

Packaging

- Sterile single blister pack
- Non-sterile options
- Without or with cap.

Customization

- Plunger color options 
- Clear or Amber barrel options 



Conformance & Compliance

- ISO 7886-1 - ISO 80369-1
- EU 2017/745 (MDR)
- EO sterilized
- Shelf life: 5 years

Available Sizes & Types

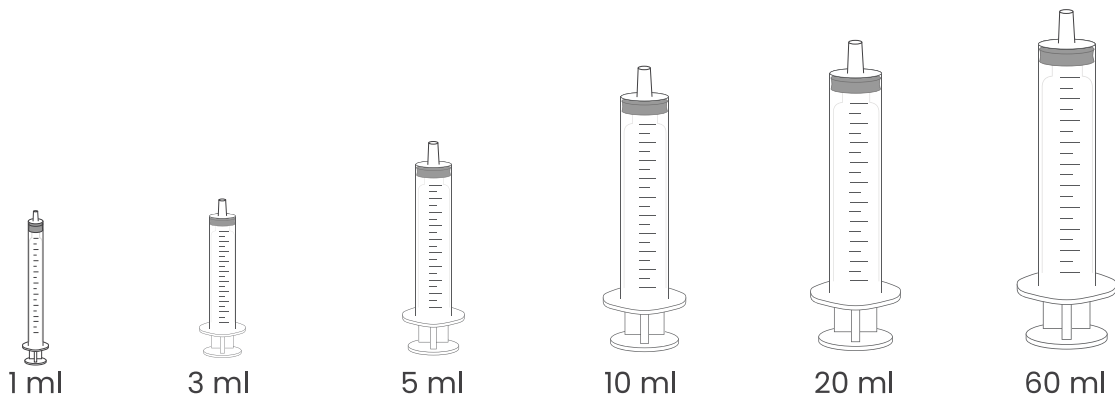

Product Table

Size	Graduated Capacity	Inner Box	Carton Qty
1 ml	1 ml	100/500 pcs	3200/3000 pcs
3 ml	3 ml	100/350 pcs	2400/2800 pcs
5 ml	5 ml	100/250 pcs	1600/2000 pcs
10 ml	10 ml	100/150 pcs	1200/1200 pcs
20 ml	20 ml	100 pcs	600 pcs
60 ml	60 ml	60 pcs	240 pcs



Set® ENFit®

Features

- Designed for precise enteral medication delivery and fluid measurement
- Smooth and controlled plunger movement with silicone lubrication
- Latex-free gasket ensuring excellent sealing
- Clear, easy-to-read graduation for accurate dosing
- Available in 1 ml, 3 ml, and 5 ml sizes ensuring enhanced micro-dosing accuracy
- Fully compatible with ENFit® Standard and ENFit® Low Dose connectors
- Transparent barrel for clear visibility during feeding and dosing
- Single-use device ensuring patient and caregiver safety

Packaging

- Sterile single blister pack
- Non-sterile options
- Without or with cap.

Customization

- Plunger color options 
- Clear or Amber barrel options 



Conformance & Compliance

- ISO 7886-1 – ISO 20695 – ISO 80369-1 – ISO80369-3
- EU 2017/745 (MDR)
- EO sterilized
- Shelf life: 5 years

Available Sizes & Types

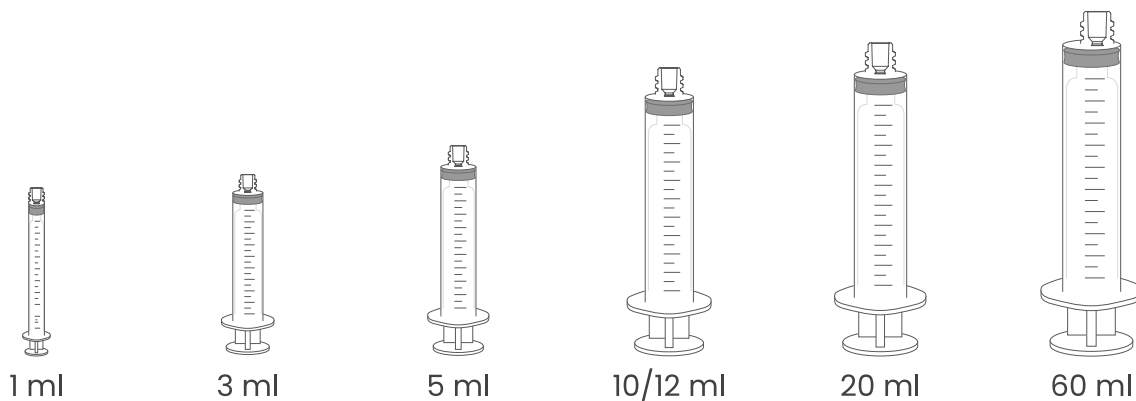

Product Table

Size	Concentric	Eccentric	Low Dose Tip	Standard Tip	Graduated Capacity	Inner Box	Carton Qty
1 ml	•		•		1ml	100/500 pcs	3200/3000 pcs
3 ml	•		•		3ml	100/350 pcs	2400/2800 pcs
5 ml	•		•	•	5ml	100/250 pcs	1600/2000 pcs
10/12 ml	•			•	10ml	100/150 pcs	1200/1200 pcs
20 ml	•			•	20ml	100 pcs	600 pcs
60 ml		•		•	60ml	60 pcs	240 pcs





set[®] diabetes

Daily diabetes management relies on tools that feel trustworthy and familiar.

Our diabetes care range focuses on comfort, precision, and ease of use, offering insulin syringes and needles

that support users in their everyday routines.

These products are developed to deliver consistent dosing while fitting seamlessly into the rhythm of self-care.



We care.

Diabetes Instruction

Our DIABETES offerings

For syringes, proper dosage accuracy and a needle tip that meets standard requirements are of great importance.



Various medical devices are used during the diabetes management process. These include syringes designed for accurate dosing and insulin pens used for insulin administration.



Thin walled body and specific angled sharp tip that minimizes pain



For insulin pens, a pen needle is attached to the tip of the pen. This product is essential for subcutaneous injection of insulin and helps make the application process easier.

set[®] diabetes

Insulin Syringes



We care.



Set® Insulin

Features

- Luer Slip tip, compatible with U-100 insulin
- Precise and smooth plunger movement with medical-grade silicone lubrication
- Excellent sealing performance with latex-free isoprene rubber gasket
- No air leakage through gasket or needle junction
- Clear and legible graduation (0.01 ml / 0.02 ml depending on model)
- Fixed needle (26G / 29G / 30G / 31G) or 6% Luer tip depending on syringe type
- Transparent barrel for easy insulin level visibility
- Designed for safe, single-handed subcutaneous insulin administration
- Durable structure compliant with intended injection pressure

Packaging

- Sterile or non-sterile
- With single or double cap
- Without or with needle. (bi-packed)
- Without or with aspiration or filter needle

Conformance & Compliance

- ISO 8537 - ISO 80369-7 - ISO 9626
- EU 2017/745 (MDR)
- FDA 510(k) Cleared
- EO sterilized
- Shelf life: 5 years

Available Sizes & Types

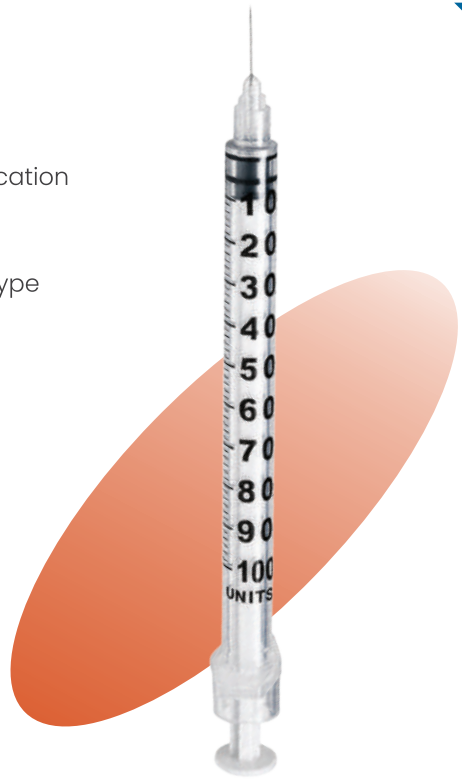

Insulin Syringe with needle (bi-packed)



26G x 1/2"
0.45 x 13 mm



Double Cap Insulin Syringe



29G x 1/2"
0.33 x 13 mm



Single Cap Insulin Syringe

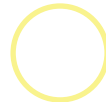

30G x 5/16"
0.30 x 8 mm



31G x 5/16"
0,25x12mm

Product Table

Product Description	Syringe Volume	Units / Box	Units / Carton
0,3ml 3-Part 29Gx1/2	0.3 ml	100/450 pcs	2400/2700 pcs
0,3ml 3-Part 30Gx5/16	0.3 ml	100/450 pcs	2400/2700 pcs
0,3ml 3-Part 31Gx5/16	0.3 ml	100/450 pcs	2400/2700 pcs
0,5ml 3-Part 29Gx1/2	0.5 ml	100/450 pcs	2400/2700 pcs
0,5ml 3-Part 30Gx5/16	0.5 ml	100/450 pcs	2400/2700 pcs
0,5ml 3-Part 31Gx5/16	0.5 ml	100/450 pcs	2400/2700 pcs
01ml 3-Part 29Gx1/2	1 ml	100/450 pcs	2400/2700 pcs
01ml 3-Part 30Gx5/16	1 ml	100/450 pcs	2400/2700 pcs
01ml 3-Part 30Gx1/2	1 ml	100/450 pcs	2400/2700 pcs
01ml 3-Part 26Gx1/2	1 ml	100/250 pcs	2400/3000 pcs

set[®] diabetes

Pen Needle



We care.



Set[®] Lance

Features

- Manufactured with SS304 stainless-steel needle
- Atraumatic, triple-bevel tip design for smooth and comfortable penetration
- Silicone lubrication ensuring consistent, low-friction needle entry
- Polypropylene hub, protective cap and needle shield
- Suitable for use with all standard insulin pens
- Available in multiple gauges and lengths for patient-specific dosing (30G–32G, 4–8 mm)
- Designed for safe, single-use insulin injection

Conformance & Compliance

- 93/42/EEC (MDD)
- ISO 7864 - ISO 11608-2
- EO sterilized
- Shelf life: 5 years



Thin walled body and specific angled sharp tip that minimizes pain



Available Sizes & Types



Product Table

Size	Needle Gauge (G)	Units / Box	Units / Carton
30G x 8mm	30	100 pcs	6000 pcs
31G x 4mm	31	100 pcs	6000 pcs
31G x 5mm	31	100 pcs	6000 pcs
31G x 6mm	31	100 pcs	6000 pcs
31G x 8mm	31	100 pcs	6000 pcs
32G x 4mm	32	100 pcs	6000 pcs
32G x 6mm	32	100 pcs	6000 pcs
32G x 8mm	32	100 pcs	6000 pcs





set[®] infusion

Infusion therapy touches nearly every clinical discipline, and our range covers the essential devices behind these interventions.

From vascular access to controlled fluid delivery, each product is designed to perform reliably in busy care environments.

This category brings together solutions that help clinicians maintain continuity and control throughout treatment.



We care.

Infusion Instruction

Have You Heard About Our Infusion Family?

Perfusion Syringe:
Designed for precise and controlled fluid infusion.

IV Cannula:
Provides safe and reliable intravenous access.

Saline Syringe:
Sterile saline solution for line flushing and cleaning.

Flow Regulator:
Helps adjust and maintain a steady flow rate.

Three-Way Stopcock:
Allows easy control of multiple fluid pathways.

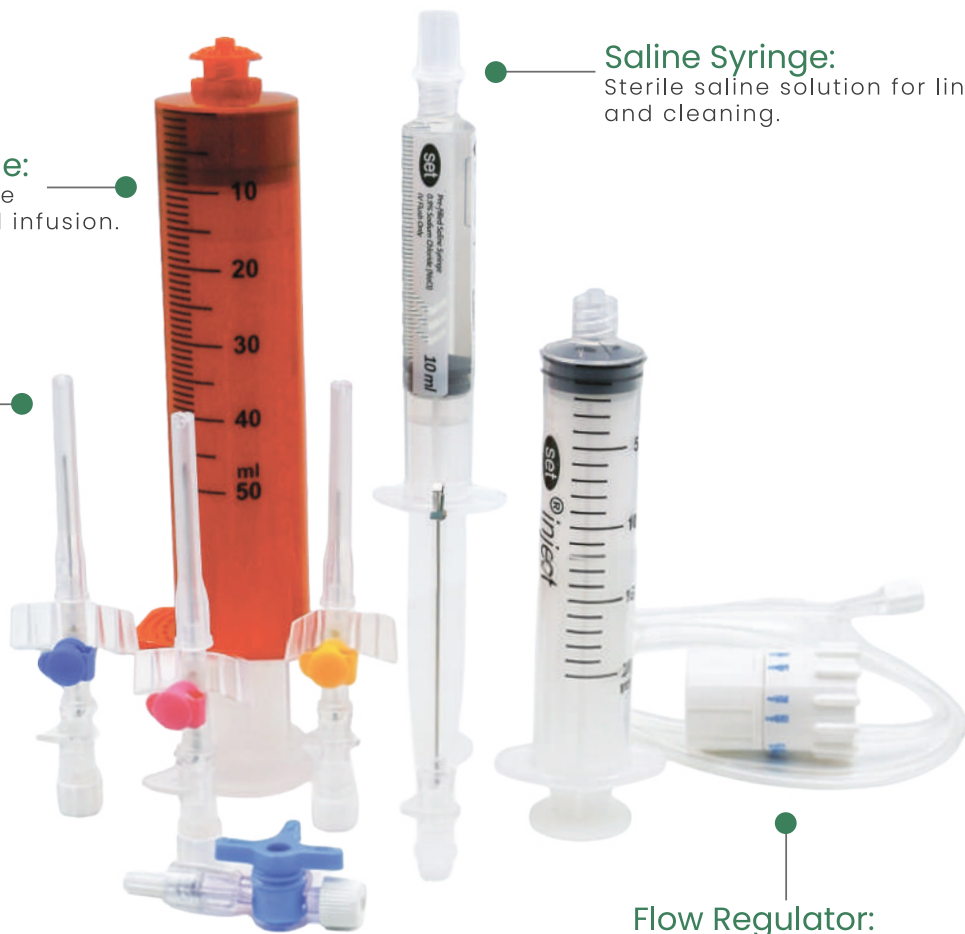

set[®] infusion

Vascular Access

IV Cannula



We care.



Set® IV Cannula

Features

- Atraumatic, back-bevel stainless-steel needle design for smooth and controlled venous entry
- FEP catheter tubing providing flexibility and high biocompatibility
- Transparent needle hub and chamber for clear blood flashback visualization
- No air leakage between needle, hub, or catheter components
- Stable gripping wings for secure handling during insertion
- Luer lock cap ensuring leak-proof sealing
- Ported versions include an additional injection port for medication administration
- Color-coded hub or cap for clear gauge identification
- Single-use sterile device supporting patient and user safety

Conformance & Compliance

- ISO 10555-1 – ISO 10555-5
- 93/42/EEC (MDD)
- EO sterilized
- Shelf life: 5 years



Available Sizes & Types

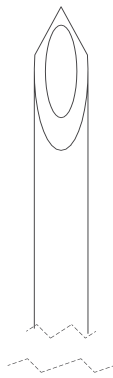

18 G ●

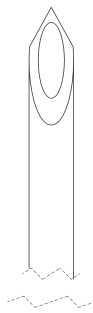

20 G ●

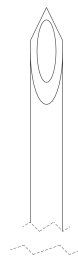

22 G ●

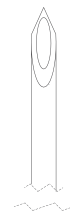

24 G ●

Product Table

Size (G)	Product Description	Units / Box	Units / Case
18 ●	IV Catheter 18G with Wings & Port (Non-safety)	50 pcs	500 pcs
20 ●	IV Catheter 20G with Wings & Port (Non-safety)	50 pcs	500 pcs
22 ●	IV Catheter 22G with Wings & Port (Non-safety)	50 pcs	500 pcs
24 ●	IV Catheter 24G with Wings & Port (Non-safety)	50 pcs	500 pcs

set[®] infusion

Fluid Delivery Systems

Sets and Accessories



We care.



Set® IV Set

Features

- Designed for gravity-feed IV infusion of diagnostic or therapeutic solutions
- Smooth flow-rate control enabled by precise roller mechanism
- DEHP-free PVC tubing helping minimize DEHP exposure
- Transparent tubing allowing easy identification of air bubbles
- Standard spike enabling controlled, non-damaging penetration into IV bags and bottles
- Compatible with all universal Luer Slip and Luer Lock connectors
- Optional Y-injection port or flash bulb for additional medication administration
- Single-use, sterile device ensuring patient and user safety

Packaging

- With or without drip chamber (vented / non-vented)
- With or without filter
- With y-connector or flash bulb
- With or without flow regulator

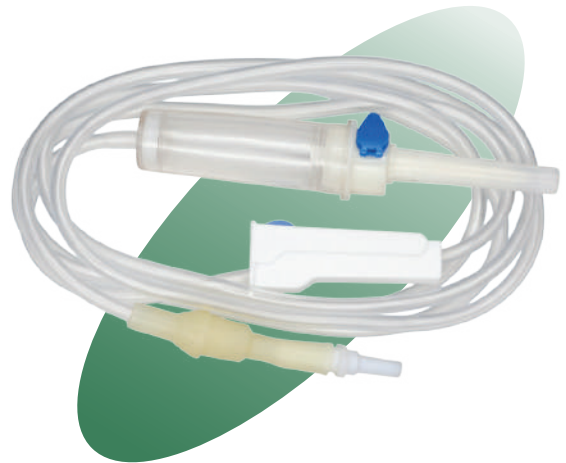

Conformance & Compliance

- ISO 8536-4 • 93/42/EEC (MDD) • EO sterilized • Shelf life: 5 years

Product Table

Description	Luer Slip / Luer Lock		Injection Port	Length (cm)	Units Carton
With Needle 21GX1 1/2"	•	•	Y site	150cm	300 pcs
Without Needle	•	•	Y site	150cm	300 pcs
With Needle 21GX1 1/2"	•	•	Flash Bulb	150cm	300 pcs
Without Needle	•	•	Flash Bulb	150cm	300 pcs



Set® Flow

Features

- Precise flow regulation
- Luer-Lock fitting for safe connection
- flow rates and offers spike protection for safe disposal
- DEHP-free tubing avoids DEHP exposure

Packaging

- Sterile single-use packaging

Conformance & Compliance

- ISO 8536-13
- 93/42/EEC (MDD)
- EO sterilized
- Shelf life: 5 years

Product Table

Description	Flow Range	Units Carton
Flow Regulator	5 to 250 ml/h	250pcs



Set® Extension

Features

- Designed to extend the fluid path between the infusion source and the patient
- Compatible with all universal Luer Slip and Luer Lock connectors
- Smooth and controlled fluid delivery through DEHP-free PVC or co-extruded PVC-PE tubing
- Transparent tubing allowing easy detection of air bubbles
- Suitable for use with power-driven infusion pumps
- Single-use sterile device ensuring patient and user safety

Packaging

- Individually blister packed
- Medical-grade paper and transparent EO-compatible film
- Available with Luer Slip or Luer Lock connector caps

Conformance & Compliance

- ISO 8536-9
- 93/42/EEC (MDD)
- EO sterilized
- Shelf life: 5 years

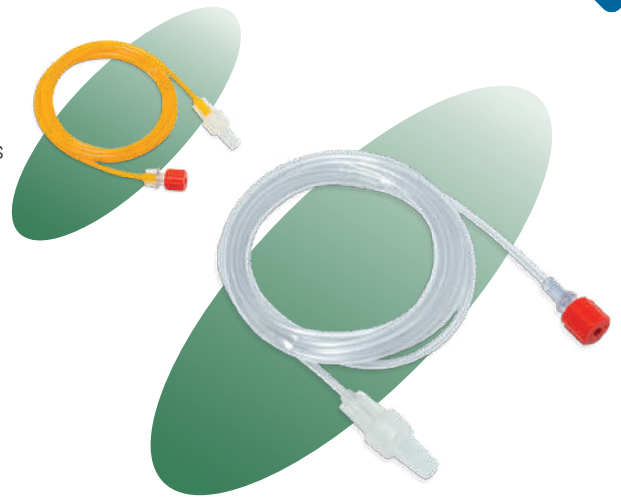

Product Table

Diameter	Amber	Transparent	CO-EX	PVC	Length (cm)	Units Carton
1,0 x 2,7 mm	●		●		150cm	800 pcs
1,0 x 2,7 mm		○	●		150cm	800 pcs
1,5 x 2,7 mm	●			●	150cm	800 pcs
1,5 x 2,7 mm		○		●	150cm	800 pcs

Set® Stopcock

Features

- Provides all convenient size syringes & volumes
- DEHP-Free, PVC-Free, Latex Free
- Sterile, non-pyrogenic and non-toxic
- Pressure resistance up to 5 bar (72 psi)
- High leak-tightness

Conformance & Compliance

- ISO 80369-7 - ISO 8536-10
- 93/42/EEC (MDD)
- EO sterilized
- Shelf life: 5 years

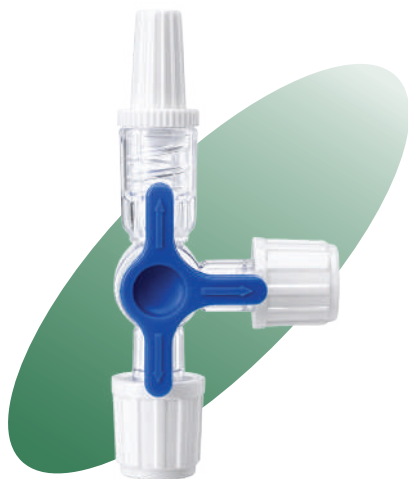

Product Table

Description	Compressive Strength	Units Box	Units Carton
Three Way (Blue)	5 Bar (72 psi)	50pcs	1000pcs





We care.



set[®] catheters

Catheterization is central to many diagnostic and therapeutic procedures, requiring devices that work smoothly and predictably.

Our catheter portfolio includes a variety of solutions for access, drainage, and fluid management, all designed to support efficient workflows and dependable performance in daily practice.



We care.

Catheters Instruction

Our CATHETER offerings

Procedures can be performed using different vacuum catheters for different purposes. Some catheters are vacuum-controlled.

They can be available in different types and forms, ranging from airway clearance to rectal catheters or urinary bladder catheters.



Rectal Catheters - Tiemann Catheter - Nelaton Catheters - Suction Catheters



Set® Cath Respiratory Care

Suction Catheters

Features

- Smooth surface enabling easy and controlled insertion
- Optimal stiffness preventing kinking during use
- Atraumatic, rounded open distal tip minimizing tissue trauma
- Two side holes designed to prevent tissue aspiration (cross-oriented holes available in specific models)
- Available tip designs: Bevel Tip and Straight / Ideal Tip
- Color-coded funnel connector for quick size identification
- Optional vacuum control connector providing effective suction regulation
- Universal connector for all models
- Standard catheter length: 50 cm



Conformance & Compliance

- 93/42/EEC (MDD)
- ISO 8836

Available Sizes & Types

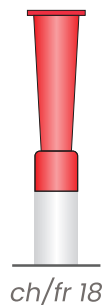
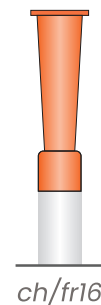
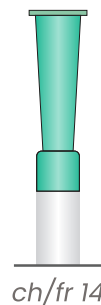
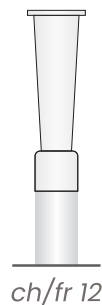
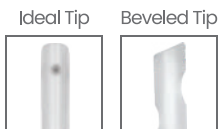

Product Table

Size	Ideal Tip	Beveled Tip	Units Per Box (Vacuum Control)	Units Per Box (Regular)
● ch/fr 10	●	●	100pcs	150pcs
● ch/fr 12	●	●	100pcs	150pcs
● ch/fr 14	●	●	100pcs	150pcs
● ch/fr 16	●	●	100pcs	150pcs
● ch/fr 18	●	●	100pcs	150pcs



Set® Cath Urology Care

Tiemann Catheters

Features

- Designed for effective catheterization in obstructed or narrow passages
- Smooth surface enabling easy and controlled insertion
- Optimal stiffness preventing kinking during advancement
- Atraumatic, rounded angled closed distal tip minimizing tissue irritation
- Cross-positioned double side holes helping maintain uninterrupted flow
- Color-coded connector for quick size identification
- Standard catheter length: 40

Conformance & Compliance

- 93/42/EEC (MDD)



Available Sizes & Types



ch/fr 10

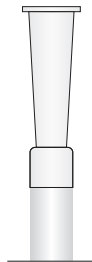

ch/fr 12

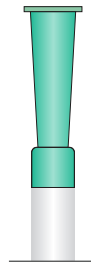

ch/fr 14

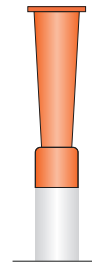

ch/fr16

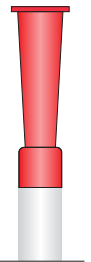

ch/fr 18

Product Table

Size	Units Per Box	Units Per Case
● ch/fr 10	100pcs	1000pcs
● ch/fr 12	100pcs	1000pcs
● ch/fr 14	100pcs	1000pcs
● ch/fr 16	100pcs	1000pcs
● ch/fr 18	100pcs	1000pcs



Set® Cath Gastrointestinal Care

Rectal Catheters

Features

- Smooth surface enabling easy and controlled insertion
- Optimal stiffness preventing kinking during use
- Atraumatic, rounded closed distal tip minimizing tissue irritation
- Cross-positioned double side holes designed to improve fluid drainage
- Color-coded connector for quick size identification
- Standard catheter length: 40 cm

Conformance & Compliance

- 93/42/EEC (MDD)



Available Sizes & Types

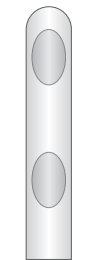

ch/fr 18

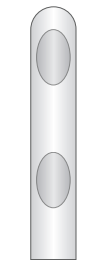

ch/fr 20

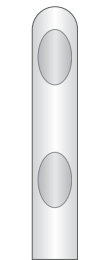

ch/fr 22

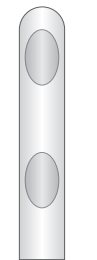

ch/fr 24

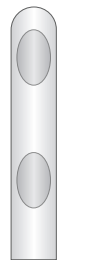

ch/fr 26

Product Table

Size	Units Per Box	Units Per Case
ch/fr 18	75pcs	750pcs
ch/fr 20	75pcs	750pcs
ch/fr 22	75pcs	750pcs
ch/fr 24	75pcs	750pcs
ch/fr 26	75pcs	750pcs



Packaging & Sterility Options



We care.



Sterile Packaging

Bi-packed

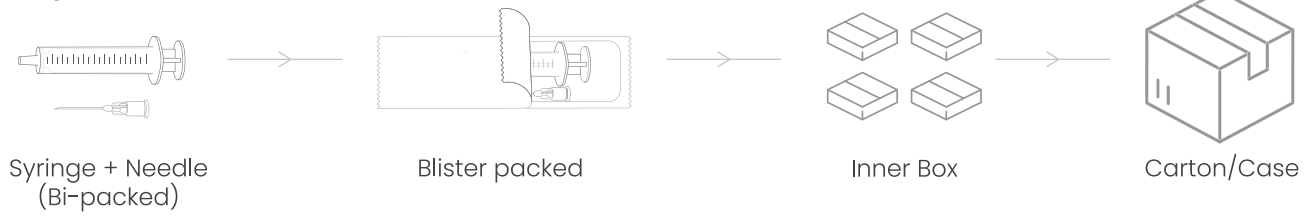

Single-packed

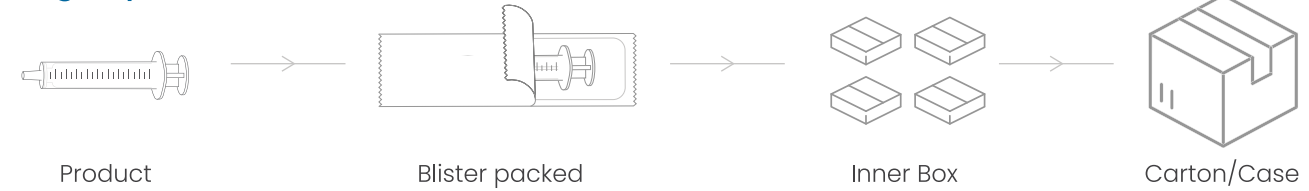

Combo

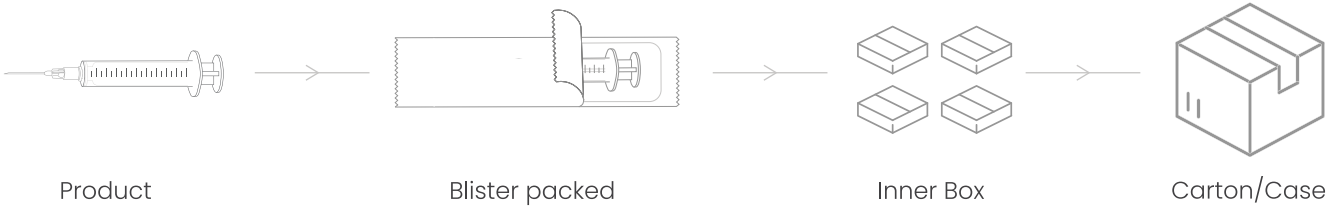

Tray

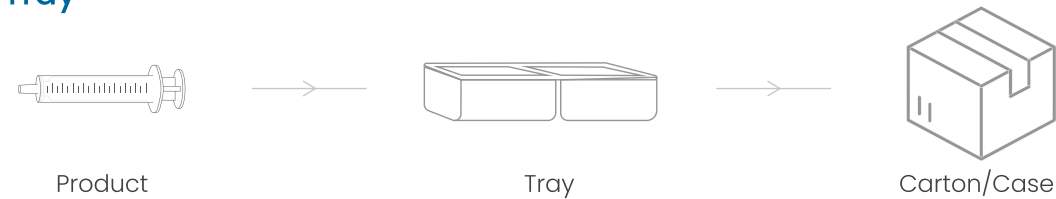

Non-Sterile Packaging

Standard Bulk



Mini Bulk

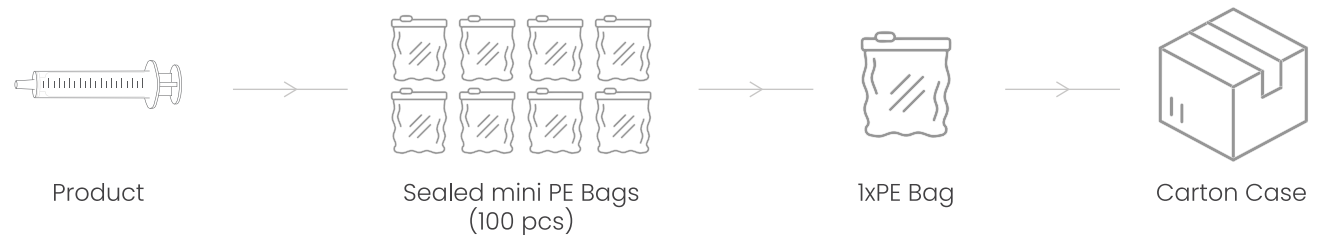



T: +90 212 622 04 00
info@setmedikl.com.tr
www.setmedikal.com.tr

Catalog

